

PRODUCT CODE: SFC25/50P
PVC / STEEL FLEXIBLE CONDUIT

DESCRIPTION

25mm PVC Coated Steel Flexible Conduit - 50mtr Coil

FINISH

Black PVC Coated

MATERIAL

Pre Galvanised Steel

PACKAGING

Packed in qty 1

ADDITIONAL NOTES

IP65 Rated
RoHS Compliant
Temperature Range: -20°C to +80°C

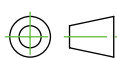
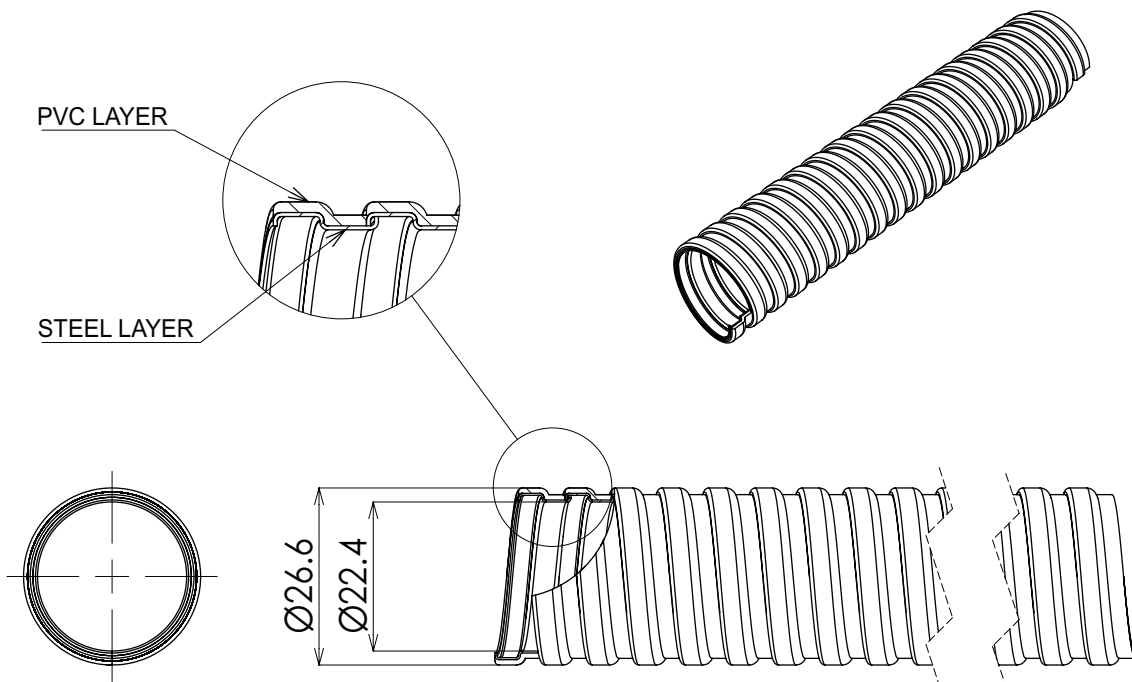

Values are nominal and with a general tolerance $\pm 5\%$ unless otherwise specified